

HARTNER

Precision Cutting Tools

THREAD MILLING CUTTERS

THE COMPLETE PROGRAMME





















+ NEW: Micro thread milling cutters from M1.4

ISO code

P	Steel, high-alloyed steel
M	Stainless steel
K	Grey cast iron, spher. graphite iron/malleable cast iron
N	Aluminium and other non-ferrous metals
S	Special, super and titanium alloys
H	Hardened steel and chilled cast iron

Pictograms

Tool material	VHM
	Solid carbide
Surface	 
	TiCN TiAlN
Type	     
Thread depth	  
Standard	 to Hartner Standard
Cutting direction	
	right
Shank form	 
	to DIN 6535
Thread type	
	Through holes/blind holes
Internal cooling	 
	with IC without IC

Tool Selection Guide

p. 4



GFR – Thread milling cutters without chamfer

p. 8

Simple option for thread milling one thread size
Thread types: M, MF, UNF, UNC, NPT, G



GFR S – Thread milling cutters with 45° chamfer

p. 16

High productivity thanks to countersinking and thread milling with one tool,
high running smoothness and low lateral forces.
Thread types: M, MF, G



GFR U – Universal thread milling cutter with recessed neck

p. 20

For different thread sizes with equal pitch, e.g. thread
M30x1.5, milling cutter $\varnothing 12 \times M1.5$, $\varnothing 16 \times M1.5$ or $\varnothing 20 \times M1.5$
Thread types: internal threads: M, MF | internal and external threads: G, NPT

NEW

MGFR – Micro thread milling cutters

p. 24



MGFR 3
Thread size and pitch are predetermined



(3xD) M1.6–M16, G1/8" - G2", UNC, UNF, UNJC, UNJF, MJ, solid carbide TiCN



MGFR 1
Universal production of nominal thread diameters up to maximum pitch



(3xD) M1.4–M10, solid carbide TiCN



MGFRH 3
Machining of hardened steels from 45 HRC – 65 HRC



(2xD–3xD) M2–M12, solid carbide TiAlN



Our service

p. 28

Free supply of CNC programmes

$v_c = \text{m/min}$
 $f = \text{mm/U}$

Technical section

p. 32

General information & application recommendations

Tool Selection Guide

Thread depth	$\leq 2xD$		$\leq 2.5xD$	$\leq 2xD$
Tool material	Solid carbide			
Type	GFR	GFR	GFR	GFR S
Surface				
Coolant supply		axial	axial	axial
Shank form	HA	HA	HA	HA
Spiral	27°	27°	27°	10°
 <p>Through holes and blind holes</p>				
Thread type	Article no.			
M	80300 p. 8	80301 p. 9	80312 p. 14	80309 p. 16
MF		80301 p. 9		80311 p. 17
UNC		80306 p. 10		
UNF		80307 p. 11		
G		80302 p. 12		
NPT		80304 p. 13		
EG	EG-threads can be produced with every thread milling cutter type and dimension			
Suitable lubricant	So/No	So/No	So/No	So/No

So = Soluble oil
A = Air
No = Neat oil
D = Dry

universal/ internal thread	universal/ external thread	≤3xD		
Solid carbide				
GFR U	GFR U	MGFR 3	MGFR 1	MGFRH 3
C	C	C	C	A
axial	axial	☒	☒	☒
HA	HA	HA	HA	HA
15°	15°	15°	15°	15°
			 universal	 Hard machining
Article no.				
80310 p. 20		80350 p. 24	80353 p. 26	80355 p. 27
80310 p. 20			80353 p. 26	
		80351 p. 25		
		80351 p. 25		
80303 p. 21	80303 p. 21			
80305 p. 22	80305 p. 22			
EG-threads can be produced with every thread milling cutter type and dimension				
So/No	So/No	So/No	So/No	A/D

What are the advantages of thread milling compared with tapping and thread forming?

- Different materials can be machined with one tool (aluminium, steel, cast iron, stainless steel, titanium, Inconel, max. HRC 65 and many more)
- Various diameters and tolerances are possible with one tool (e.g. 6H+0.1, 7G, EG and many more)
- One tool for through and blind holes as well as right- and left-hand threads
- Thread depth possible up to the base of the hole (0.5xP)
- No axial cross-cutting
- Saving tool locations (with type GFR S)
- Problem-free chips because short milling chips are produced
- Reduced tooling costs with the same pitch and large threads (type GFR U)
- Short cycle times thanks to high cutting speed and feed rate
- High process reliability even in the event of tool breakage as the thread milling cutter can be completely removed from the workpiece and the machine
- High economic efficiency thanks to Hartner's re-grind and re-coating service



GFR – Thread milling cutters without chamfer



Free CNC programming on request!

Programming example Type GFR

Article no.	80301 TiCN	Cutting speed [vc]	80 m/min
Thread size	M10x(1)	Feed per tooth	0.05 mm
Thread depth	20 mm / Blind hole	Processing sequence	Reverse rotation milling
Material	St- 37	Processing time	6.9 seconds

CNC programme

N10 M6 T1			
N20 G90 G54 G00 X0 Y0			
N30 Z2 S3203 M3 M8		Position over workpiece	
N40 Z-18.70		Position for thread depth	
N50 G91		Incremental	
N60 G42 G01 X0 Y3.975 F50		Radius compensation	
N70 G02 X0 Y-9.005 I0 J-4.503 Z-0.150		Entry cycle 180°	
N80 G02 X0 Y0 I0 J5.030 Z-1.000 F101		Thread pitch 360°	
N90 G02 X0 Y9.005 I0 J4.503 Z-0.150		Withdrawal cycle 180°	
N100 G40 G01 X0 Y-3.975		Radius compensation off	
N110 G90		Switch to absolute	
N120 G00 Z2 M9		Rapid movement to start position	
N130 M30			





Thread milling cutters without chamfer for ISO metric threads

Article no. 80300



P	M	K	N	S	H
•	○	•	•	○	≤55



without chamfer

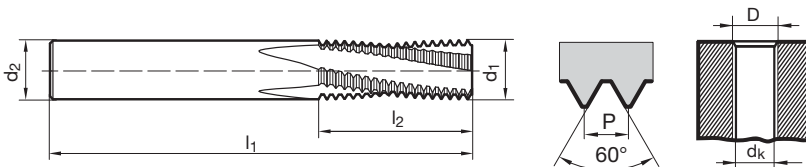

D	P mm	d1 mm	d2 mm	dk mm	l1 mm	l2 mm	Z	Code no.
M6	1.000	4.800	6.000	5.00	54.000	13.500	3	6.000
M8	1.250	6.400	8.000	6.80	62.000	18.100	3	8.000
M10	1.500	7.950	10.000	8.50	74.000	21.800	3	10.000
M12	1.750	9.950	10.000	10.20	74.000	25.400	4	12.000
M14	2.000	11.200	12.000	12.00	90.000	31.000	4	14.000
M16	2.000	12.800	14.000	14.00	90.000	35.000	4	16.000
M20	2.500	14.950	16.000	17.50	102.000	41.300	4	20.000



Thread milling cutters without chamfer for ISO metric threads/fine threads

Article no. 80301



P	M	K	N	S	H
•	○	•	•	○	≤55



without chamfer

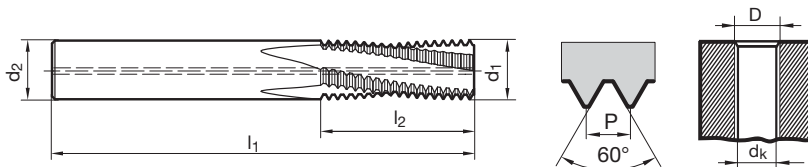

D	P mm	d1 mm	d2 mm	dk mm	l1 mm	l2 mm	Z	Code no.
M6	1.000	4.800	6.000	5.00	54.000	13.500	3	6.000
M8	1.250	6.400	8.000	6.80	62.000	18.100	3	8.000
M8 x 1	1.000	6.400	8.000	7.00	62.000	17.500	3	8.005
M10	1.500	7.950	10.000	8.50	74.000	21.800	3	10.000
M10 x 1	1.000	7.950	10.000	9.00	74.000	21.500	3	10.005
M10 x 1,25	1.250	7.950	10.000	8.80	74.000	21.900	3	10.006
M12	1.750	9.950	10.000	10.20	74.000	25.400	4	12.000
M12 x 1,5	1.500	9.950	10.000	10.50	74.000	26.300	4	12.007
M14	2.000	11.200	12.000	12.00	90.000	31.000	4	14.000
M14 x 1,5	1.500	11.200	12.000	12.50	90.000	30.800	4	14.007
M16	2.000	12.800	14.000	14.00	90.000	35.000	4	16.000
M16 x 1,5	1.500	12.800	14.000	14.50	90.000	33.800	4	16.007
M20	2.500	14.950	16.000	17.50	102.000	41.300	4	20.000
M20 x 1,5	1.500	14.950	16.000	18.50	102.000	42.800	4	20.007



Thread milling cutters without chamfer for UNC-threads

Article no. 80306



P	M	K	N	S	H
•	○	•	•	○	≤55



without chamfer

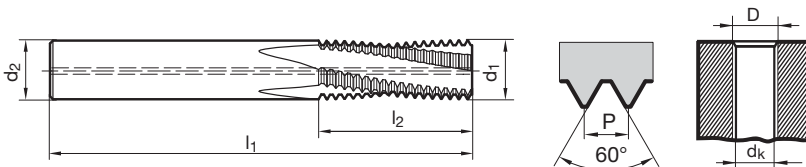

D	d1 mm	d2 mm	dk mm	l1 mm	l2 mm	Z	Code no.
10 - 24	3.400	6.000	3.90	54.000	11.100	3	4.826
12 - 24	4.100	6.000	4.50	54.000	12.200	3	5.486
1/4 - 20	4.700	6.000	5.10	54.000	14.600	3	6.350
5/16 - 18	6.100	8.000	6.60	64.000	17.600	3	7.938
3/8 - 16	7.600	8.000	8.00	64.000	21.400	3	9.525
7/16 - 14	9.000	10.000	9.40	74.000	24.500	3	11.113
1/2 - 13	9.950	10.000	10.80	74.000	28.300	4	12.700
9/16 - 12	11.400	12.000	12.20	90.000	30.700	4	14.288
5/8 - 11	12.700	14.000	13.50	90.000	35.800	4	15.875



Thread milling cutters without chamfer for UNF-threads

Article no. 80307



P	M	K	N	S	H
•	○	•	•	○	≤55



without chamfer

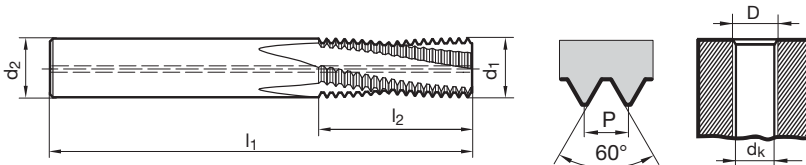

D	d1 mm	d2 mm	dk mm	l1 mm	l2 mm	Z	Code no.
10 - 32	3.800	6.000	4.10	54.000	11.500	3	4.826
12 - 28	4.300	6.000	4.60	54.000	12.200	3	5.486
1/4 - 28	5.100	6.000	5.50	54.000	14.100	3	6.350
5/16 - 24	6.300	8.000	6.90	64.000	17.500	3	7.938
3/8 - 24	7.800	8.000	8.50	64.000	20.600	3	9.525
7/16 - 20	9.400	10.000	9.90	74.000	24.800	3	11.113
1/2 - 20	9.950	10.000	11.50	74.000	27.300	4	12.700
9/16 - 18	11.400	12.000	12.90	90.000	30.300	4	14.288
5/8 - 18	12.700	14.000	14.50	90.000	33.200	4	15.875



Thread milling cutters without chamfer for BSP-threads

Article no. 80302



P	M	K	N	S	H
•	○	•	•	○	≤55



without chamfer

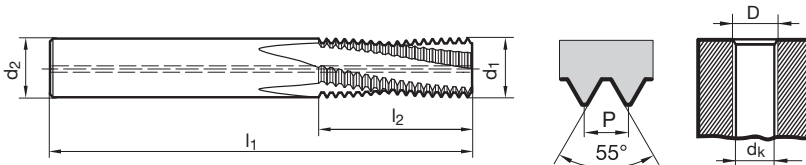

D	P inch	d1 mm	d2 mm	dk mm	l1 mm	l2 mm	Z	Code no.
G1/8	28.000	7.950	8.000	8.80	64.000	21.300	3	9.728
G1/4	19.000	10.500	12.000	11.80	90.000	28.700	4	13.157
G3/8	19.000	13.600	14.000	15.25	90.000	35.400	4	16.662



Thread milling cutters without chamfer for NPT-threads

Article no. 80304



P	M	K	N	S	H
•	○	•	•	○	≤55



without chamfer

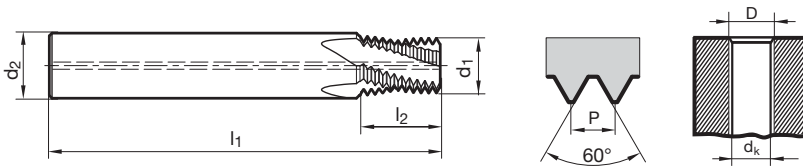

D	P inch	d1 mm	d2 mm	dk mm	l1 mm	l2 mm	Z	Code no.
1/16	27.000	5.900	8.000	6.15	54.000	9.900	3	8.190
1/8	27.000	7.300	8.000	8.40	64.000	9.900	3	10.620
1/4	18.000	9.950	12.000	11.10	72.000	19.000	4	14.140
3/8	18.000	12.500	14.000	14.30	80.000	14.800	4	17.570



Thread milling cutters without chamfer for ISO metric threads

Article no. 80312



P	M	K	N	S	H
•	○	•	•	○	≤55



without chamfer

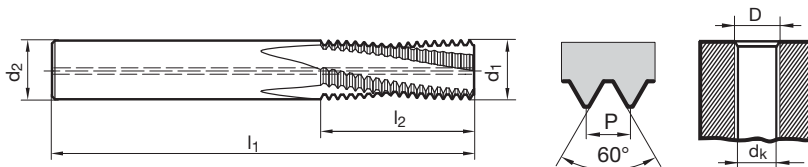

D	P mm	d1 mm	d2 mm	dk mm	l1 mm	l2 mm	Z	Code no.
M6	1.000	4.800	6.000	5.00	54.000	16.500	3	6.000
M8	1.250	6.400	8.000	6.80	62.000	21.900	3	8.000
M10	1.500	7.950	10.000	8.50	74.000	26.300	3	10.000
M12	1.750	9.950	10.000	10.20	74.000	32.400	4	12.000
M14	2.000	11.200	12.000	12.00	90.000	37.000	4	14.000
M16	2.000	12.800	14.000	14.00	90.000	43.000	4	16.000
M20	2.500	14.950	16.000	17.50	102.000	48.800	4	20.000

GFR S – Thread milling cutters with 45° chamfer



Free CNC programming on request!

Programming example Type GFR S

Article no.	80311 TiCN	Cutting speed [vc]	100 m/min
Thread size	M12x(1.5)	Feed per tooth	0.075 mm
Thread depth	18 mm / Blind hole	Processing sequence	Reverse rotation milling
Material	42CrMo4	Processing time	4.15 seconds
CNC programme			
N10 M6 T1			
N20 G90 G54 G00 X0 Y0			
N30 Z2 S1600 M3 M8		Position over workpiece	
N40 Z-26.20		Position for 45° countersinking	
N50 G01 Z-27.57 F85		Chamfering 45°	
N60 G00 Z-16.05 S3199		Position for thread depth	
N70 G91		Incremental	
N80 G42 G01 X0 Y4.975 F85		Radius compensation	
N90 G02 X0 Y-11.015 I0 J-5.508 Z-0.225		Entry cycle 180°	
N100 G02 X0 Y0 I0 J6.040 Z-1.5 F169		Thread pitch 360°	
N110 G02 X0 Y11.015 I0 J5.508 Z-0.225		Withdrawal cycle 180°	
N120 G40 G01 X0 Y-4.975		Radius compensation off	
N130 G90		Switch to absolute	
N140 G00 Z2 M9		Rapid movement to start position	
N150 M30			





Thread milling cutters with chamfer for ISO metric threads

Article no. 80309



P	M	K	N	S	H
•	•	•	•	•	≤55



with chamfer

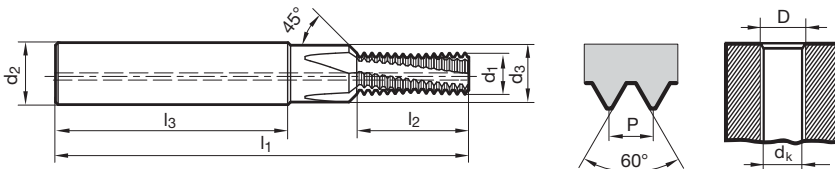

D	P mm	d1 mm	d2 mm	d3 mm	dk mm	l1 mm	l2 mm	l3 mm	Z	Code no.
M3	0.500	2.300	6.000	3.400	2.50	48.000	6.800	36.000	3	3.000
M4	0.700	3.000	6.000	4.500	3.30	48.000	8.800	36.000	3	4.000
M5	0.800	4.000	6.000	5.500	4.20	54.000	10.800	36.000	3	5.000
M6	1.000	4.800	8.000	6.600	5.00	62.000	13.500	36.000	3	6.000
M8	1.250	6.400	10.000	9.000	6.80	74.000	18.100	40.000	3	8.000
M10	1.500	7.950	12.000	11.000	8.50	80.000	21.800	45.000	4	10.000
M12	1.750	9.950	14.000	13.500	10.20	90.000	25.400	45.000	4	12.000
M14	2.000	11.200	16.000	15.500	12.00	102.000	31.000	48.000	4	14.000
M16	2.000	12.800	18.000	17.500	14.00	102.000	35.000	48.000	4	16.000
M20	2.500	14.500	20.000	21.500	17.50	125.000	41.300	50.000	4	20.000



Thread milling cutters with chamfer for ISO metric fine threads

Article no. 80311



P	M	K	N	S	H
•	•	•	•	•	≤55



with chamfer

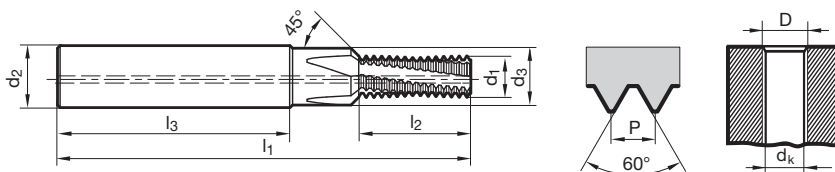

D	P mm	d1 mm	d2 mm	d3 mm	dk mm	l1 mm	l2 mm	l3 mm	Z	Code no.
M4 x11,0	0.700	3.000	6.000	4.500	3.30	48.000	12.300	36.000	3	4.003
M5 x 0,5	0.500	4.000	6.000	5.500	4.50	54.000	10.800	36.000	3	5.003
M6 x 0,5	0.500	4.800	8.000	6.600	5.50	62.000	12.800	36.000	3	6.003
M6 x 0,75	0.750	4.800	8.000	6.600	5.20	62.000	13.100	36.000	3	6.004
M8 x 0,75	0.750	6.400	10.000	9.000	7.20	74.000	16.900	40.000	3	8.004
M8 x 1	1.000	6.400	10.000	9.000	7.00	74.000	17.500	40.000	3	8.005
M10 x 1	1.000	7.950	12.000	11.000	9.00	80.000	21.500	45.000	4	10.005
M10 x 1,25	1.250	7.950	12.000	11.000	8.80	80.000	21.900	45.000	4	10.006
M12 x 1	1.000	9.950	14.000	13.500	11.00	90.000	25.500	45.000	4	12.005
M12 x 1,5	1.500	9.950	14.000	13.500	10.50	90.000	26.300	45.000	4	12.007
M14 x 1,5	1.500	11.200	16.000	15.500	12.50	102.000	30.800	48.000	4	14.007
M16 x 1,5	1.500	12.800	18.000	17.500	14.50	102.000	33.800	48.000	4	16.007



Application example type GFR U

Material: AISi7

Thread: M20 x 1.5 und M16 x 1.5

Thread depth: 12 mm/13 mm

Tool: GFR U, Article no. 80310

Lubrication: Soluble oil 8 %

Parameters: $v_c=260\text{ m/min.}$, $f_z=0.06\text{ mm}$

Milling method: Reverse rotation milling

Tool life: 38 000 threads



GFR U – Universal thread milling cutter

with recessed neck



Free CNC
programming
on request!

Programming example Type GFR U

Article no.	80310 Ø 12xM1 TiCN	Cutting speed [vc]	60 m/min
Thread size	M28x1	Feed per tooth	0.05 mm
Thread depth	12 mm / Blind hole	Processing sequence	Reverse rotation milling
Material	VA [1.4301]	Processing time	28.96 seconds
CNC programme			
N10 M6 T1			
N20 G90 G54 G00 X0 Y0			
N30 Z2 S1598 M3 M8		Position over workpiece	
N40 Z-10.70		Position for thread depth	
N50 G91		Incremental	
N60 G42 G01 X0 Y5.975 F92		Radius compensation	
N70 G02 X0 Y-20.015 I0 J-10.008 Z-0.150		Entry cycle 180°	
N80 G02 X0 Y0 I0 J14.040 Z-1.000 F184		Thread pitch 360°	
N90 G02 X0 Y20.015 I0 J10.008 Z-0.150		Withdrawal cycle 180°	
N100 G40 G01 X0 Y-5.975		Radius compensation off	
N110 G90		Switch to absolute	
N120 G00 Z2 M9		Rapid movement to start position	
N130 M30			





Universal thread milling cutters for ISO metric threads

Article no. 80310



P	M	K	N	S	H
•	•	•	•	•	≤55



universal thread milling cutters for internal threads M / MF

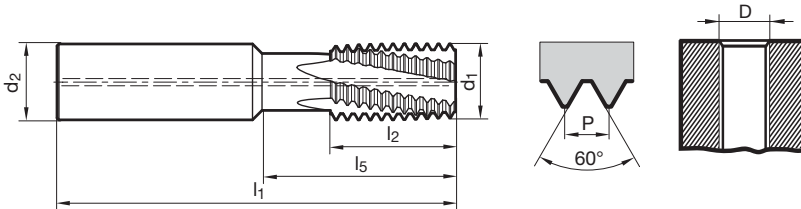

P mm	D	d1 mm	d2 mm	l1 mm	l2 mm	l5 mm	Z	Code no.
0.500	> 10	7.950	8.000	64.000	20.000		4	8.050
1.000	> 12	9.950	10.000	70.000	16.000	25.000	4	10.100
1.250	> 14	9.950	10.000	70.000	16.000	25.000	4	10.125
1.500	> 14	9.950	10.000	70.000	16.000	25.000	4	10.150
1.000	> 16	11.950	12.000	80.000	20.000	31.000	4	12.100
1.250	> 16	11.950	12.000	80.000	20.000	31.000	4	12.125
1.500	> 16	11.950	12.000	80.000	20.000	31.000	4	12.150
1.000	> 18	15.950	16.000	90.000	25.000	40.000	5	16.100
1.500	> 20	15.950	16.000	90.000	25.000	40.000	5	16.150
2.000	> 22	15.950	16.000	90.000	25.000	40.000	5	16.200
3.000	> 24	17.950	18.000	102.000	33.000	50.000	5	18.300
1.000	> 24	19.950	20.000	105.000	33.000	50.000	5	20.100
1.500	> 26	19.950	20.000	105.000	33.000	50.000	5	20.150
2.000	> 26	19.950	20.000	105.000	33.000	50.000	5	20.200
3.000	> 27	19.950	20.000	105.000	33.000	50.000	5	20.300
3.500	> 30	19.950	20.000	105.000	33.000	50.000	5	20.350



Universal thread milling cutters for BSP-threads

Article no. 80303



P	M	K	N	S	H
•	•	•	•	•	≤55



Universal thread milling cutters for internal and external threads

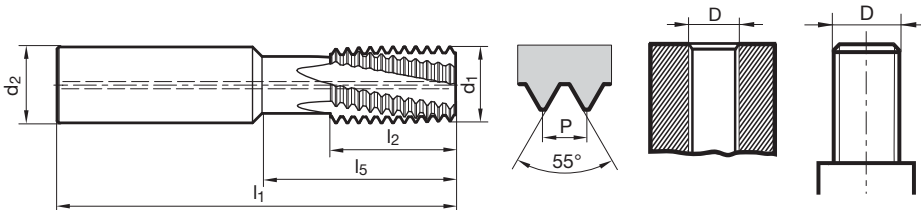

P	D	d1	d2	l1	l2	l5	Z	Code no.
inch		mm	mm	mm	mm	mm		
19.000	> 1/4	9.950	10.000	70.000	16.000	25.000	4	10.190
14.000	> 1/2	15.950	16.000	90.000	25.000	40.000	5	16.140
11.000	> 1	19.950	20.000	105.000	33.000	50.000	5	20.110



Universal thread milling cutters for NPT-threads

Article no. 80305



P	M	K	N	S	H
•	•	•	•	•	≤55



Universal thread milling cutters for internal and external threads

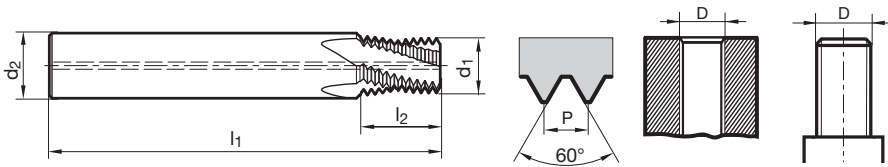

P inch	D	d1 mm	d2 mm	l1 mm	l2 mm	Z	Code no.
14.000	≥ 1/2	14.500	16.000	90.000	19.050	5	21.900
11.500	≥ 1	18.500	20.000	90.000	23.190	5	34.180

MGFR – Micro thread milling cutters



Micro thread milling cutters

Solid carbide micro thread milling cutters have been specially developed for the production of threads in small holes:

- excellent characteristics in higher-strength materials (e.g. titanium alloys, stainless steels, ...)
- blind holes and through holes up to 3xD
- minimum cutting force
- very good thread quality
- short machining times
- also suitable for softer materials (e.g. aluminium or plastics)

Free CNC programming on request!

Programming example Type MGFR 3

Material	TiAl6V4
Thread	M3, depth 7.0 mm / Blind hole
Tool	80350 MGFR 3 M3x(0.5) tool Ø 2.4 mm Z=3
Parameter	$v_c = 40$ m/min, $f_z = 0.025$ (Reverse rotation milling) $v_f = 398$ mm/min, $v_m = 84$ mm/min
N10 M6 T1	
N20 G90 G54 G00 X0 Y0	
N30 Z2 S5305 M3 M8	
N40 Z0.1	
N50 G91	
N60 G42 G01 X0 Y1.200 F42	
N70 G02 X0 Y-2.720 I0 J-1.360 Z-0.075	
N80 G02 X0 Y0 I0 J1.520 Z-0.500 F84	
Number of repeats of set N80 =15	
N90 G02 X0 Y2.720 I0 J1.360 Z-0.075	
N100 G40 G01 X0 Y-1.200	
N110 G90	
N120 G00 Z2 M9	
N130 M30	

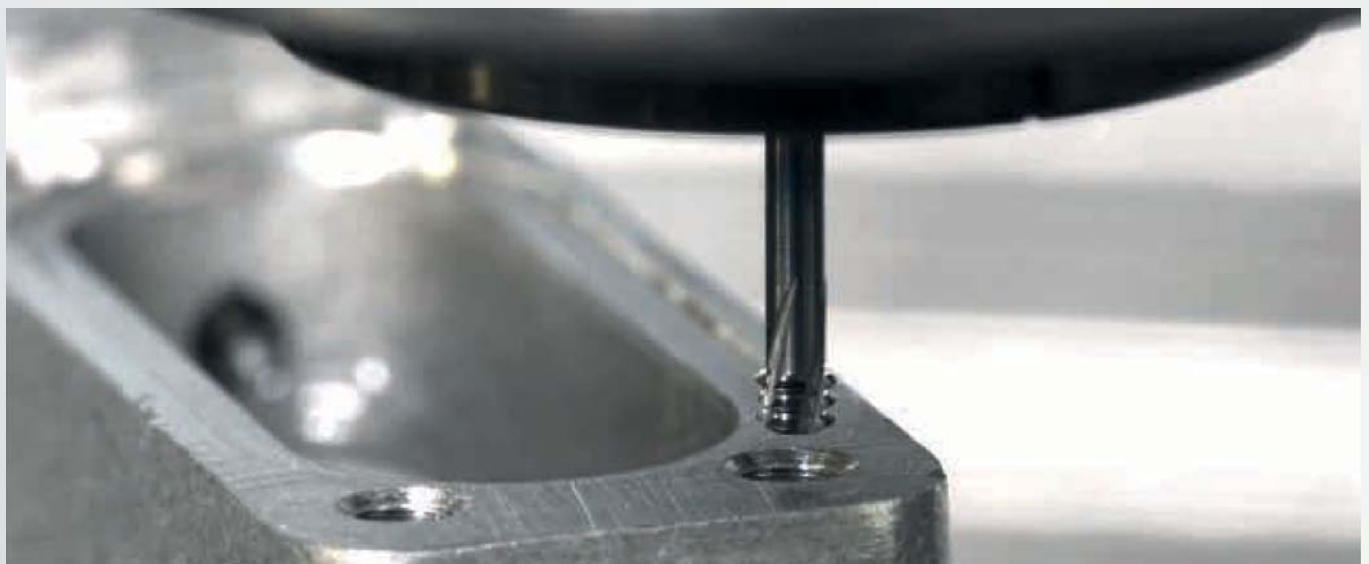



Micro thread milling cutters

Article no. 80350



P	M	K	N	S	H
•	•	•	•	•	



Thread size and pitch are predetermined

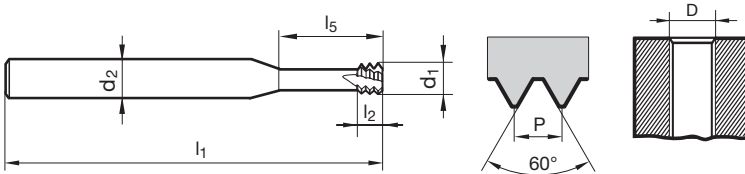

D	P mm	d1 mm	d2 mm	l1 mm	l2 mm	l5 mm	Z	Code no.
M1,6	0.350	1.200	3.000	39.000	1.100	4.800	3	1.600
M1,8	0.350	1.400	3.000	39.000	1.100	5.400	3	1.800
M2	0.400	1.550	3.000	39.000	1.200	6.000	4	2.000
M2,5	0.450	1.950	3.000	39.000	1.400	7.500	4	2.500
M3	0.500	2.400	6.000	58.000	1.500	9.500	4	3.000
M3,5	0.600	2.800	6.000	58.000	1.800	11.000	4	3.500
M4	0.700	3.200	6.000	58.000	2.100	12.500	4	4.000
M5	0.800	4.000	6.000	58.000	2.400	16.000	4	5.000
M6	1.000	4.800	6.000	58.000	3.000	20.000	4	6.000
M8	1.250	5.950	6.000	58.000	3.800	24.000	4	8.000
M10	1.500	7.800	8.000	73.000	4.500	33.000	4	10.000
M12	1.750	9.000	10.000	84.000	5.300	38.000	4	12.000
M16	2.000	11.800	12.000	84.000	6.000	35.000	5	16.000



Micro thread milling cutters

Article no. 80351



P	M	K	N	S	H
•	•	•	•		



Thread size and pitch are predetermined

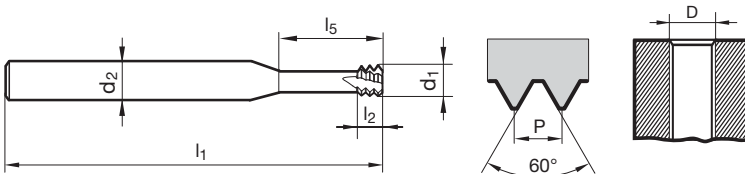

D	P inch	d1 mm	d2 mm	l1 mm	l2 mm	l5 mm	Z	Code no.
UNC No 2+UNF No 3	56	1.650	3.000	39.000	1.400	7.000	4	2.184
UNC No 3+UNF No 4	48	1.900	3.000	39.000	1.600	8.000	4	2.515
UNC No 4	40	2.100	6.000	58.000	1.900	9.000	4	2.845
UNC No 5+UNF No 6	40	2.450	6.000	58.000	1.900	10.000	4	3.175
UNC No 6	32	2.550	6.000	58.000	2.400	11.000	4	3.505
UNF No 8	36	3.300	6.000	58.000	2.100	12.000	4	4.165
UNC No 8	32	3.200	6.000	58.000	2.400	13.000	4	4.166
UNF No10	32	3.700	6.000	58.000	3.200	15.000	4	4.825
UNC No10+UNC No12	24	3.500	6.000	58.000	3.200	16.000	4	4.826
UNF No12	28	4.200	6.000	58.000	2.700	16.000	4	5.485
UNF 1/4	28	5.000	6.000	58.000	2.700	19.600	4	6.349
UNC 1/4	20	4.750	6.000	58.000	3.800	20.000	4	6.350
UNF 5/16+UNF 3/8	24	6.600	8.000	64.000	3.200	24.000	4	7.937
UNC 5/16	24	6.000	6.000	58.000	4.200	23.000	4	7.938
UNC 3/8	16	6.700	8.000	64.000	4.800	25.000	4	9.525
UNF 7/16	20	8.000	8.000	64.000	3.800	34.600	4	11.112
UNF 5/8	18	12.000	12.000	84.000	4.200	35.000	4	15.874



Micro thread milling cutters

Article no. 80353



P	M	K	N	S	H
•	•	•	•		



Universal production of nominal thread diameters up to maximum pitch

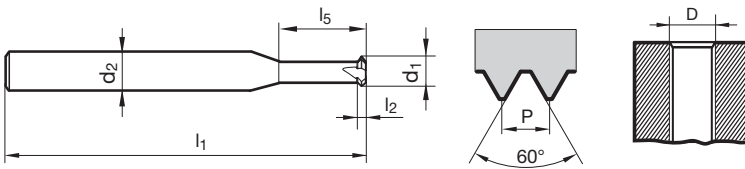

D	P max. mm	d1 mm	d2 mm	l1 mm	l2 mm	l5 mm	Z	Code no.
M1.4 - M1.8	0.350	1.050	3.000	39.000	0.400	3.800	3	1.800
M2 - M2.4	0.400	1.500	3.000	39.000	0.400	7.000	3	2.400
M2.5 - M3	0.500	2.000	3.000	39.000	0.500	9.000	4	3.000
M3.5 - M4.5	0.750	2.800	6.000	58.000	0.800	14.000	4	4.500
M5 - M7	1.000	4.000	6.000	58.000	1.000	19.000	4	7.000
M8 - M10	1.500	6.400	8.000	64.000	1.500	24.000	5	10.000



Micro thread milling cutters

Article no. 80355



P	M	K	N	S	H
				○	●



for hard machining 45-65 HRC • Thread size and pitch are predetermined

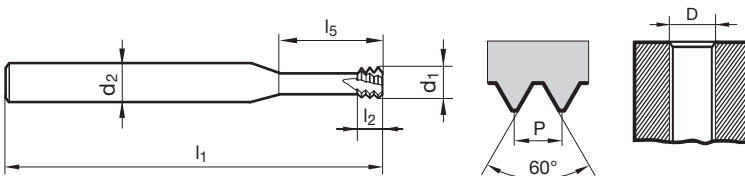

D	P mm	d1 mm	d2 mm	l1 mm	l2 mm	l5 mm	Z	Code no.
M2	0.400	1.550	3.000	39.000	1.200	6.000	4	2.000
M2,5	0.450	1.950	3.000	39.000	1.400	7.500	4	2.500
M3	0.500	2.350	6.000	58.000	1.500	9.500	4	3.000
M4	0.700	3.100	6.000	58.000	2.100	12.500	4	4.000
M5	0.800	3.800	6.000	58.000	2.400	16.000	4	5.000
M6	1.000	4.800	6.000	58.000	3.000	20.000	4	6.000
M8	1.250	5.950	6.000	58.000	3.800	24.000	4	8.000
M10	1.500	7.800	8.000	64.000	4.500	23.000	4	10.000
M12	1.750	9.000	10.000	73.000	5.300	26.000	5	12.000

Our Service

Free Creation of CNC Programmes

To make the machining with our thread milling cutters as easy as possible, we set up the suitable CNC programme for your individual application and machine control.

For the programme creation we only require:

- thread type and size
- material to be machined
- desired Hartner article no.
- type of machine control

We supply you with the programming data, which can be automatically recognised and read. The programming data is available for Sinumerik, Heidenhain, Fanuc, Mazatrol and Hurco.

Furthermore, with each programme, you will receive a CNC data sheet with all parameters, see page on the right.

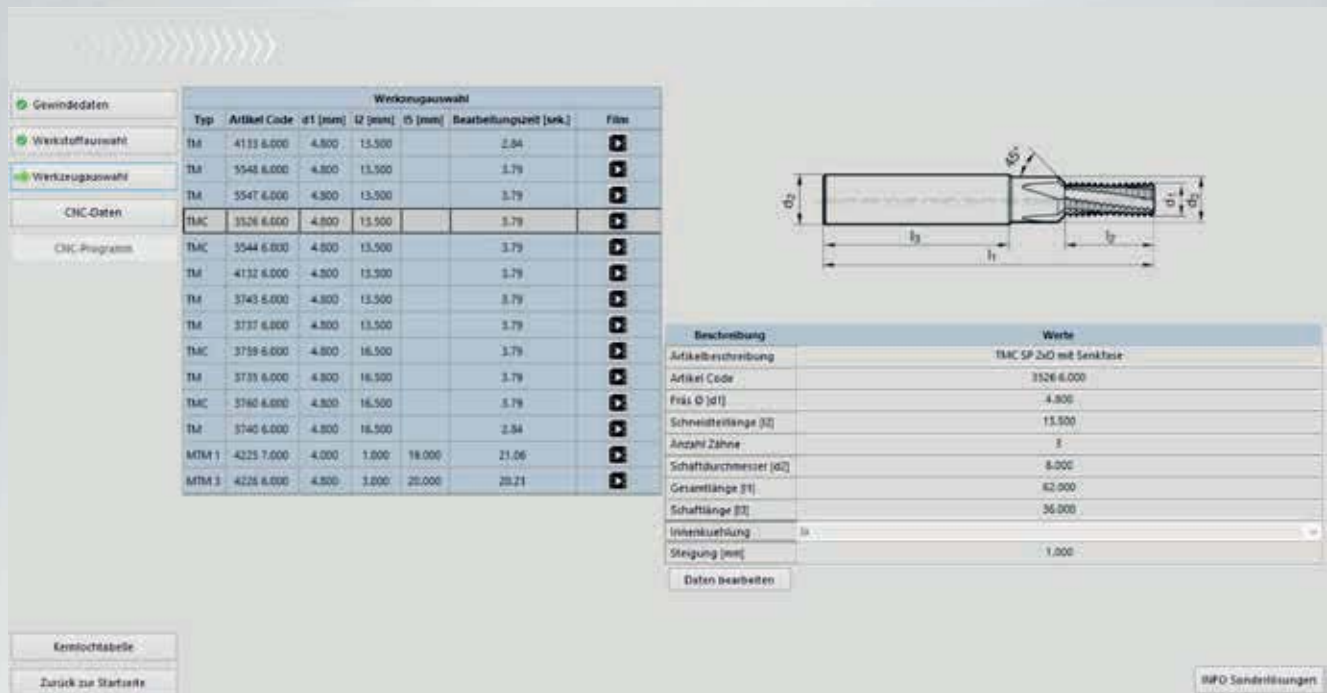

The screenshot displays a software interface for CNC programming. On the left, a sidebar contains navigation options: 'Gewindedaten', 'Werkstoffauswahl', 'Werkzeugauswahl', 'CNC-Daten', and 'CNC-Programm'. The main area features a table titled 'Werkzeugauswahl' (Tool Selection) with columns for 'Typ', 'Artikel Code', 'd1 [mm]', 'l2 [mm]', 'l5 [mm]', 'Bearbeitungszeit [sek]', and 'File'. Below this table is a technical drawing of a cylindrical part with a thread, showing dimensions d_1 , l_2 , l_5 , and d_2 . To the right of the drawing is a table with 'Bezeichnung' (Description) and 'Werte' (Values) for various parameters. At the bottom left, there are buttons for 'Kernlochabete' and 'Zurück zur Startseite'. At the bottom right, there is a button for 'Daten bearbeiten' and a logo for 'BFO Sonderlösungen'.

Typ	Artikel Code	d1 [mm]	l2 [mm]	l5 [mm]	Bearbeitungszeit [sek]	File
TM	4133 8.000	4.800	13.500		2.84	
TM	5548 8.000	4.800	13.500		3.79	
TM	5547 8.000	4.800	13.500		3.79	
TMC	3526 6.000	4.800	13.500		3.79	
TMC	5544 6.000	4.800	13.500		3.79	
TM	4132 8.000	4.800	13.500		3.79	
TM	3743 8.000	4.800	13.500		3.79	
TM	3737 8.800	4.800	13.500		3.79	
TMC	3759 6.000	4.800	16.500		3.79	
TM	3733 8.000	4.800	16.500		3.79	
TMC	3780 8.800	4.800	16.500		3.79	
TM	3740 6.000	4.800	16.500		2.84	
MTM1	4225 7.000	4.000	1.000	18.000	21.06	
MTM3	4226 8.000	4.800	3.000	20.000	20.21	

Bezeichnung	Werte
Artikelbeschreibung	TMC SP 2x0 mit Senkbohr
Artikel Code	3526 6.000
Fräs Ø [d1]	4.800
Schneidteilänge [l2]	13.500
Anzahl Zähne	3
Schaftdurchmesser [d2]	6.000
Gesamtlänge [l1]	62.000
Schaftlänge [l3]	36.000
Innenkuhlung	<input type="checkbox"/>
Steigung [mm]	1.000

BFO Sonderlösungen

Free CNC programming



HARTNER

CNC Data Sheet



Hartner GmbH
P.O. Box 10 04 27
D-72425 Albstadt
Tel.: +49 74 31/1 25-0
Fax: +49 74 31/1 25-21 547
www.hartner.de

Date 01.03.2018

Machining Task		Material
Thread Dimension	M10	Structural- and free cutting steels, unalloyed tempered-/case hardened
Length	16.00 mm	
Countersink W=90°	No	

Tool		Cutting Values	
Description	GFR 2xD without chamfer	Milling	
Milling cutter diameter	d1 = 7.95 mm	Vc	90 m/min n 3604 1/min
Programmed Radius	3.94 mm	fz	0.045 mm/tooth
Order-No.	80301_10.000	Vf	486 mm/min Vm 100 mm/min

NC-Options		Cycle Time	
Machine Control	Sinumerik [DIN]	Total Time	7.05 sec.
Cutting Path	Center path, incremental		
Milling Process	Conventional milling		
No. of passes	One cut		

Note CNC programme serves as a programming example and should be tested by simulation before use on component.

CNC-Code

```
; Tool= GFR 2xD without chamfer M10
; Material= P1
; Vc=90 m/min
; fz=0.045 mm/tooth
; Conventional milling
; One cut
; Thread Type= Internal Right-Hand Thread
N10 M6 T1
N20 G90 G54 G00 X0.000 Y0.000
N30 Z2.000 S3604 M3 M8
```

Attention, for controls that refer to outer path, values in brackets to be used.

The background features a technical drawing of a mechanical part with various dimensions labeled: d_1 , d_2 , d_3 , H_1 , H_2 , H_3 , p , and p_1 . A pencil is positioned diagonally across the drawing. In the foreground, two calipers are shown, with their scales clearly visible. The scales on the calipers are marked from 0 to 25, with major increments every 5 units and minor increments every 1 unit. The overall image has a light green and white color scheme.

TECHNICAL SECTION



The Hartner thread milling cutter types

GFR – Thread milling cutters without chamfer



- Simple and cost-efficient tool for the milling of internal threads
- 2-3 thread sizes with the same pitch can be produced over the specified nominal dimension
- Application in materials $\leq 1000 \text{ N/mm}^2$
- Available with or without internal cooling

Thread types: M, MF, UNC, UNF, G, NPT

GFR S – Thread milling cutters with 45° chamfer



- Countersinking and thread milling with only one tool
- Very smooth running and low lateral forces
- Designed for the application of difficult-to-machine materials also available w/o countersinking step
- 2-3 thread sizes with the same pitch can be produced over the specified nominal dimension
- Only available with internal cooling

Thread types: M, MF, G

GFR U – Universal thread milling cutters with recessed neck



- Universal application possibilities
- For various thread sizes with the same pitch, e.g. thread M30x1.5 with milling cutter $\varnothing 12 \times M1.5$, $\varnothing 16 \times M1.5$ or $\varnothing 20 \times M1.5$
- Only available with internal cooling

**Thread types: Internal thread: M, MF
Internal- and external thread: G, NPT**

MGFR 3 – Micro thread milling cutters



- Thread size and pitch are predetermined
- Excellent characteristics with high-tensile materials such as titanium, stainless steel etc.
- Suitable for the machining of hardened steel 45HRC–65HRC
- Threads up to 3xD
- Only available without internal cooling; with internal cooling on request

Thread types: M, MF, UNC, UNF

MGFR 1 – Micro thread milling cutters



- Universal production of nominal thread diameters up to a maximum pitch
- Only available without internal cooling

Thread types: M, MF



Difference between taps/fluteless taps and thread milling cutters

Taps/fluteless taps

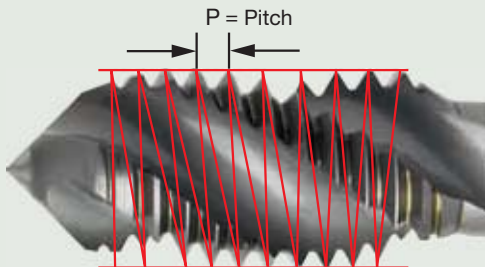

The red lines show the pitch angle of the thread that is ground into the tool. This means the pitch is cut into the workpiece by the tool.

Thread milling cutters

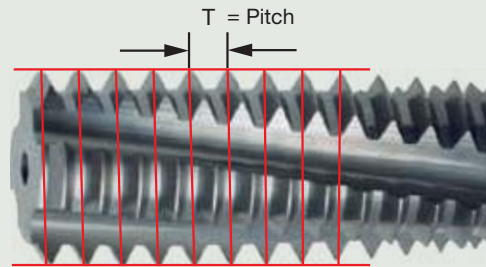

The red lines show that the tool does not possess a pitch angle. The pitch is produced by the Z-axis of a CNC machine.

Creation of the thread with thread milling



Thread profile without axial feed (Z-axis) of the machine. A groove profile is created without pitch. A functioning thread is not created.



Through the additional programming of the Z-axis the necessary pitch is produced.

Note

Due to diagonal milling in the pitch angle (Z-axis) the thread profile of the tool is transferred onto the component distorted. The more the milling cutter diameter (80 % of nom. Ø) approaches the nominal thread diameter and the higher the thread pitch the more pronounced the profile distortion is.



Distinction between two milling processes

Reverse rotation milling clockwise, with G02

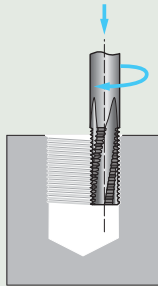

Reverse rotation milling is preferentially applied for the machining of harder materials or to remedy taper threads.

Synchronous milling anticlockwise, with G03

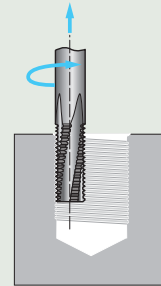

Synchronous milling is applied with thread depths smaller than $1.5 \times D$. Advantage: A better surface finish is achieved.

**Thread production with one tool
Right-hand thread reverse rotation milling**

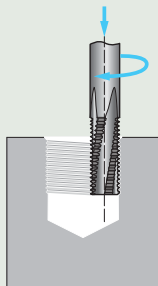

Tool rotates clockwise from top to bottom.

**Thread production with one tool
Left-hand thread reverse rotation milling**

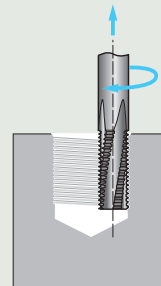

Tool rotates clockwise from bottom to top.

**Thread production with one tool
Right-hand thread synchronous milling**

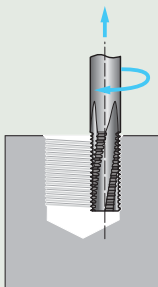

Tool rotates clockwise from bottom to top.



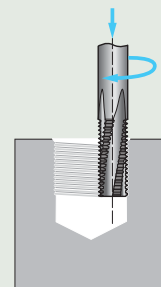



**Thread production with one tool
Left-hand thread synchronous milling**



Tool rotates clockwise from top to bottom.

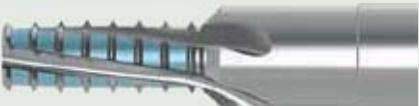

Thread milling cutter modifications

Illustration	Modification	Effect
	Cooling slots on shank	Targeted cooling, without weakening the tool cross-section in the cutting edge area
	Radial coolant exits	Targeted cooling with through hole threads
	Threads removed	Reduced cutting forces but longer machining time because two cycles are required
	De-burring cutting edge	Removing the incomplete threads at the thread run-in without additional operating step
	First thread profile lengthened at the face	Chamfering a tapping size hole
	Grinding collar	Enables axial distribution of cuts – useful for deep threads



Technical section

Taping size holes for thread milling cutters

Std. ISO metric threads DIN 13					ISO metric fine threads DIN 13					UNC threads ASME B1.1								
Nom. Ø	Pitch P	Tapping size hole Ø	Core diameter of int. thread 6H*		Nom. x Ø	Pitch P	Tapping size hole Ø	Core diameter of int. thread 6H		Nom. x Ø	Pitch P	Tapping size hole Ø	Core diameter of int. thread 2B					
	mm	DIN 336 mm	min. mm	max. mm		mm	DIN 336 mm	min. mm	max. mm		mm	DIN 336 mm	per inch	min. mm	max. mm			
M 1	0.25	0.75	0.729	0.785	M 2.5 x 0.35		2.15	2.121	2.221	M 22 x 1.50		20.50	20.376	20.676	No. 1 - 64	1.55	1.425	1.580
M 1.1	0.25	0.85	0.829	0.885	M 3.0 x 0.35		2.65	2.621	2.721	M 22 x 2.00		20.00	19.835	20.210	No. 2 - 56	1.85	1.694	1.872
M 1.2	0.25	0.95	0.929	0.985	M 3.5 x 0.35		3.15	3.121	3.221	M 24 x 1.00		23.00	22.917	23.153	No. 3 - 48	2.10	1.941	2.146
M 1.4	0.30	1.10	1.075	1.142	M 4.0 x 0.50		3.50	3.459	3.599	M 24 x 1.50		22.50	22.376	22.676	No. 4 - 40	2.35	2.157	2.385
M 1.6	0.35	1.25	1.221	1.321	M 4.5 x 0.50		4.00	3.959	4.099	M 24 x 2.00		22.00	21.835	22.210	No. 5 - 40	2.65	2.487	2.698
M 1.8	0.35	1.45	1.421	1.521	M 5.0 x 0.50		4.50	4.459	4.599	M 25 x 1.00		24.00	23.917	24.153	No. 6 - 32	2.85	2.642	2.896
M 2	0.40	1.60	1.567	1.679	M 5.5 x 0.50		5.00	4.959	5.099	M 25 x 1.50		23.50	23.376	23.676	No. 8 - 32	3.50	3.302	3.531
M 2.2	0.45	1.75	1.713	1.838	M 6.0 x 0.75		5.20	5.188	5.378	M 25 x 2.00		23.00	22.835	23.210	No. 10 - 24	3.90	3.683	3.937
M 2.5	0.45	2.05	2.013	2.138	M 7.0 x 0.75		6.20	6.188	6.378	M 27 x 1.00		26.00	25.917	26.153	No.12 - 24	4.50	4.343	4.597
M 3	0.50	2.50	2.459	2.599	M 8.0 x 0.50		7.50	7.459	7.599	M 27 x 1.50		25.50	25.376	25.676	1/4 - 20	5.10	4.978	5.258
M 3.5	0.60	2.90	2.850	3.010	M 8.0 x 0.75		7.20	7.188	7.378	M 27 x 2.00		25.00	24.835	25.210	5/16 - 18	6.60	6.401	6.731
M 4	0.70	3.30	3.242	3.422	M 8.0 x 1.00		7.00	6.917	7.153	M 28 x 1.00		27.00	26.917	27.153	3/8 - 16	8.00	7.798	8.153
M 4.5	0.75	3.70	3.688	3.878	M 9.0 x 0.75		8.20	8.188	8.378	M 28 x 1.50		26.50	26.376	26.676	7/16 - 14	9.40	9.144	9.550
M 5	0.80	4.20	4.134	4.334	M 9.0 x 1.00		8.00	7.917	8.153	M 28 x 2.00		26.00	25.835	26.210	1/2 - 13	10.80	10.592	11.024
M 6	1.00	5.00	4.917	5.153	M 10 x 0.75		9.20	9.188	9.378	M 30 x 1.00		29.00	28.917	29.153	9/16 - 12	12.20	11.989	12.446
M 7	1.00	6.00	5.917	6.153	M 10 x 1.00		9.00	8.917	9.153	M 30 x 1.50		28.50	28.376	28.676	5/8 - 11	13.50	13.386	13.868
M 8	1.25	6.80	6.647	6.912	M 10 x 1.25		8.80	8.647	8.912	M 30 x 2.00		28.00	27.835	28.210	3/4 - 10	16.50	16.307	16.840
M 9	1.25	7.80	7.647	7.912	M 11 x 0.75		10.20	10.188	10.378	M 30 x 3.00		27.00	26.752	27.252	7/8 - 9	19.50	19.177	19.761
M 10	1.50	8.50	8.376	8.676	M 11 x 1.00		10.00	9.917	10.153	M 32 x 1.50		30.50	30.376	30.676	1 - 8	22.25	21.971	22.606
M 11	1.50	9.50	9.376	9.676	M 12 x 1.00		11.00	10.917	11.153	M 32 x 2.00		30.00	29.835	30.210	1 1/8 - 7	25.00	24.638	25.349
M 12	1.75	10.20	10.106	10.441	M 12 x 1.25		10.80	10.647	10.912	M 33 x 1.50		31.50	31.376	31.676	1 1/4 - 7	28.00	27.813	28.524
M 14	2.00	12.00	11.835	12.210	M 12 x 1.50		10.50	10.376	10.676	M 33 x 2.00		31.00	30.835	31.210	1 3/8 - 6	30.75	30.353	31.115
M 16	2.00	14.00	13.835	14.210	M 14 x 1.00		13.00	12.917	13.153	M 33 x 3.00		30.00	29.752	30.252	1 1/2 - 6	34.00	33.528	34.290
M 18	2.50	15.50	15.294	15.744	M 14 x 1.25		12.80	12.647	12.912	M 35 x 1.50		33.50	33.376	33.676	1 3/4 - 5	39.50	38.938	39.802
M 20	2.50	17.50	17.294	17.744	M 14 x 1.50		12.50	12.376	12.676	M 36 x 1.50		34.50	34.376	34.676	2 - 4.5	45.00	44.679	45.593
M 22	2.50	19.50	19.294	19.744	M 15 x 1.00		14.00	13.917	14.153									
M 24	3.00	21.00	20.752	21.252	M 15 x 1.50		13.50	13.376	13.676									
M 27	3.00	24.00	23.752	24.252	M 16 x 1.00		15.00	14.917	15.153									
M 30	3.50	26.50	26.211	26.771	M 16 x 1.25		14.80	14.647	14.912									
M 33	3.50	29.50	29.211	29.771	M 16 x 1.50		14.50	14.376	14.676									
M 36	4.00	32.00	31.670	32.270	M 17 x 1.00		16.00	15.917	16.153									
M 39	4.00	35.00	34.670	35.270	M 17 x 1.50		15.50	15.376	15.676									
M 42	4.50	37.50	37.129	37.799	M 18 x 1.00		17.00	16.917	17.153									
M 45	4.50	40.50	40.129	40.799	M 18 x 1.50		16.50	16.376	16.676									
M 48	5.00	43.00	42.587	43.297	M 20 x 1.00		19.00	18.917	19.153									
M 52	5.00	47.00	46.587	47.297	M 20 x 1.50		18.50	18.376	18.676									
M 56	5.50	50.50	50.046	50.796	M 20 x 2.00		18.00	17.835	18.210									
					M 22 x 1.00		21.00	20.917	21.153									

* M 1.1 up to M 1.4 tapping size hole of int. thread 5H

MJ threads DIN ISO 5855					UNJC threads ISO 3161					UNJF threads ISO 3161					
Nom. Ø	x	Pitch P	Tapping size hole Ø	Core diameter of int. thread 5H*		Nom. Ø	Threads	Tapping size hole Ø	Core diameter of int. thread 3B		Nom. Ø	Threads	Tapping size hole Ø	Core diameter of int. thread 3B	
		mm	mm	min. mm	max. mm		per inch	mm	min. mm	max. mm		per inch	mm	min. mm	max. mm
MJ 3	x	0.50	2.60	2.513	2.653	No. 6	- 32	2.85	2.733	2.939	No. 6	- 40	3.00	2.888	3.053
MJ 4	x	0.70	3.40	3.318	3.498	No. 8	- 32	3.55	3.393	3.599	No. 8	- 36	3.60	3.480	3.663
MJ 5	x	0.80	4.30	4.221	4.421	No. 10	- 24	4.00	3.795	4.064	No. 10	- 32	4.20	4.054	4.255
MJ 6	x	0.50	5.55	5.513	5.625	No. 12	- 24	4.60	4.455	4.704	No. 12	- 28	4.75	4.602	4.816
MJ 6	x	0.75	5.35	5.269	5.419	1/4 - 20		5.30	5.113	5.387	1/4 - 28		5.60	5.466	5.662
MJ 6	x	1.00	5.10	5.026	5.216	5/16 - 18		6.75	6.563	6.833	5/16 - 24		7.00	6.906	7.109
MJ 8	x	0.50	7.55	7.513	7.625	3/8 - 16		8.20	7.978	8.255	3/8 - 24		8.60	8.494	8.679
MJ 8	x	0.75	7.35	7.269	7.419	7/16 - 14		9.60	9.346	9.639	7/16 - 20		10.00	9.876	10.084
MJ 8	x	1.00	7.10	7.026	7.216	1/2 - 13		11.00	10.798	11.095	1/2 - 20		11.60	11.463	11.661
MJ 8	x	1.25	6.90	6.782	6.994	9/16 - 12		12.40	12.228	12.482	9/16 - 18		13.00	12.913	13.122
MJ 10	x	1.00	9.10	9.026	9.216	5/8 - 11		13.80	13.627	13.904	5/8 - 18		14.60	14.501	14.702
MJ 10	x	1.25	8.90	8.782	8.994										
MJ 10	x	1.50	8.60	8.539	8.775										
MJ 12	x	1.75	10.40	10.295	10.560										
MJ 16	x	2.00	14.20	14.051	14.351										



Technical section

Taping size holes for thread milling cutters

UNF threads ASME B1.1				BSW (Whitworth) threads BS84				(Whitworth) threads (to DIN-ISO 228-1)				Steel armoured conduit threads to DIN 40430							
Nom. Ø	Threads per inch	Tapping size hole Ø DIN 336 mm	Core diameter of int. thread 2B		Nom. Ø	Threads per inch	Tapping size hole Ø mm	Core diameter of int. thread		Nom. Ø	Threads per inch	Tapping size hole Ø DIN 336 mm	Core diameter of int. thread		Nom. Ø	Threads per inch	Tapping size hole Ø mm	Core diameter of int. thread	
			min. mm	max. mm				min. mm	max. mm				min. mm	max. mm				min. mm	max. mm
No. 1 - 72		1.55	1.473	1.610	W 1/16	60	1.20	1.045	1.230	G 1/16	28	6.80	6.561	6.843	Pg 7	20	11.40	11.280	11.430
No. 2 - 64		1.85	1.755	1.910	W 3/32	48	1.80	1.704	1.912	G 1/8	28	8.80	8.566	8.848	Pg 9	18	14.00	13.860	14.010
No. 3 - 56		2.15	2.024	2.197	W 1/8	40	2.50	2.362	2.591	G 1/4	19	11.80	11.445	11.890	Pg 11	18	17.30	17.260	17.410
No. 4 - 48		2.40	2.271	2.459	W 5/32	32	3.20	2.952	3.214	G 3/8	19	15.25	14.950	15.395	Pg 13.5	18	19.00	19.060	19.210
No. 5 - 44		2.70	2.550	2.741	W 3/16	24	3.60	3.407	3.745	G 1/2	14	19.00	18.631	19.172	Pg 16	18	21.30	21.160	21.310
No. 6 - 40		2.95	2.819	3.023	W 7/32	24	4.50	4.201	4.539	G 5/8	14	21.00	20.587	21.128	Pg 21	16	26.90	26.780	27.030
No. 8 - 36		3.50	3.404	3.607	W 1/4	20	5.10	4.724	5.156	G 3/4	14	24.50	24.117	24.658	Pg 29	16	35.50	35.480	35.730
No. 10 - 32		4.10	3.962	4.166	W 5/16	18	6.50	6.130	6.590	G 7/8	14	28.25	27.877	28.418	Pg 36	16	45.50	45.480	45.730
No. 12 - 28		4.60	4.496	4.724	W 3/8	16	7.90	7.492	7.987	G 1	11	30.75	30.291	30.931	Pg 42	16	52.50	52.480	52.730
1/4 - 28		5.50	5.359	5.588	W 7/16	14	9.20	8.789	9.330	G 1 1/8	11	35.50	34.939	35.579	Pg 48	16	57.80	57.780	58.030
5/16 - 24		6.90	6.782	7.036	W 1/2	12	10.50	9.989	10.591	G 1 1/4	11	39.50	38.952	39.592					
3/8 - 24		8.50	8.382	8.636	W 9/16	12	12.00	11.577	12.179	G 1 1/2	11	45.25	44.845	45.485					
7/16 - 20		9.90	9.728	10.033	W 5/8	11	13.50	12.918	13.558	G 1 3/4	11	51.00	50.788	51.428					
1/2 - 20		11.50	11.328	11.608	W 3/4	10	16.25	15.797	16.483	G 2	11	57.00	56.656	57.296					
9/16 - 18		12.90	12.751	13.081	W 7/8	9	19.25	18.611	19.353										
5/8 - 18		14.50	14.351	14.681	W 1	8	22.00	21.334	22.147										
3/4 - 16		17.50	17.323	17.678	W 1 1/8	7	24.50	23.928	24.832										
7/8 - 14		20.40	20.269	20.650	W 1 1/4	7	27.75	27.103	28.007										
1 - 12		23.25	23.114	23.571	W 1 3/8	6	30.50	29.504	30.528										
1 1/8 - 12		26.50	26.289	26.746	W 1 1/2	6	33.50	32.679	33.703										
1 1/4 - 12		29.50	29.464	29.921	W 1 5/8	5	35.50	34.769	35.963										
1 3/8 - 12		32.75	32.639	33.096	W 1 3/4	5	39.00	37.944	39.138										
1 1/2 - 12		36.00	35.814	36.271	W 2	4.5	44.50	43.571	44.877										

NPT ANSI B 2.1 American tapered pipe thread 1:16									
Version A (avoid if possible)		Version B		Nom. Ø	Threads per inch	Tapp. size hole Ø cylindrical (A) d ₁	Tapp. size hole Ø conical (B) D ₁	Cutting depth ET mm	Cutting depth BT (min) mm
				1/16	- 27	6.15	6.39	9.29	10.7
				1/8	- 27	8.40	8.74	9.32	10.8
				1/4	- 18	11.10	11.36	13.52	15.6
				3/8	- 18	14.30	14.80	13.83	16.0
				1/2	- 14	17.90	18.32	18.07	20.8
				3/4	- 14	23.30	23.67	18.55	21.3
				1	- 11.5	29.00	29.69	22.29	25.6
				1 1/4	- 11.5	37.70	38.45	22.80	26.1
				1 1/2	- 11.5	43.70	44.52	22.80	26.1
				2	- 11.5	55.60	56.56	23.20	26.5
				2 1/2	- 8	66.30	67.62	31.75	36.3
				3	- 8	82.30	83.52	33.74	38.5

Metric/metric fine EG-threads (EG M14 x 1.25) for wire thread inserts DIN 8140				
Nom. Ø	x Pitch P	Tapping size hole Ø	Core diameter of int. thread	
			min. mm	max. mm
EG M 4	0.70	4.20	4.152	4.292
EG M 5	0.80	5.25	5.174	5.334
EG M 6	1.00	6.30	6.217	6.407
EG M 8	1.25	8.40	8.271	8.483
EG M10	1.50	10.50	10.324	10.560
EG M12	1.75	12.50	12.379	12.644
EG M14 x 1.25		14.40	14.271	14.483
EG M16	2.00	16.50	16.433	16.733

UNC (UNC-STI) EG-threads for wire thread inserts ASME B18.29.1				
Nom. Ø	Threads	Tapping size hole Ø	Core diameter of int. thread	
			min. mm	max. mm
EG No. 6 - 32		3.80	3.678	3.879
EG No. 8 - 32		4.40	4.338	4.524
EG No. 10 - 24		5.20	5.055	5.283
EG No. 12 - 24		5.80	5.715	5.944
EG 1/4 - 20		6.70	6.624	6.868
EG 5/16 - 18		8.40	8.242	8.489
EG 3/8 - 16		10.00	9.868	10.127
EG 7/16 - 14		11.60	11.506	11.783
EG 1/2 - 13		13.30	13.122	13.393
EG 9/16 - 12		14.90	14.747	15.032
EG 5/8 - 11		16.50	16.375	16.673

EG UNF (UNF-STI) threads for wire thread inserts ASME B18.29.1				
Nom. Ø	Threads	Tapping size hole Ø	Core diameter of int. thread	
			min. mm	max. mm
EG No. 6 - 40		3.70	3.644	3.818
EG No. 8 - 36		4.40	4.321	4.498
EG No. 10 - 32		5.10	4.999	5.184
EG No. 12 - 28		5.70	5.682	5.809
EG 1/4 - 28		6.60	6.546	6.721
EG 5/16 - 24		8.25	8.166	8.352
EG 3/8 - 24		9.80	9.754	9.931
EG 7/16 - 20		11.50	11.389	11.585
EG 1/2 - 20		13.10	12.974	13.172
EG 9/16 - 18		14.70	14.592	14.798
EG 5/8 - 18		16.25	16.180	16.386



Practical application of thread milling cutters

1. Tool clamping

good concentricity is important, therefore clamping as short and rigid as possible.

2. Enter tool data in machine memory

- Tool length from the front face, take drill/thread milling cutters (DTMC) from point.
- Measure tool radius with tool pre-setting equipment. General rule:
measured radius – 0.022 x pitch provides the input value in machine memory.

3. Input of CNC program in control

- (preferably integrated as sub-program at corresponding positions)
- Call-up of a self-controlling cycle (procedures should be known)
 - Integration of data file from our threadmill-software (DIN or Haidenhain)

4. Trial run over workpiece

- Tool length dimension in memory extending by an approximate value dependent on contact length (e.g. 30 mm) or offset zero point.
- Run program in single set, visual check of travel path.
- Allow program to run in automatic mode.

Attention

With controls where it is not definitely clear what milling path is assigned it must be clarified if the feed is positioned on the external path v_f or at the centre path v_m . As a rule we specify the milling centre point path v_m .

5. Application in workpiece

Re-set the tool extension or the zero point. Then allow the program to run in the workpiece the feed regulation must be 100% selected. Should the thread not be true to gauge, the tool radius requires correction in the tool memory:

Example:

- Thread too tight: Radius correction – input
- Thread too large: Radius correction + input





Thread milling programming

Program specifications

Thread milling functions

G00	Rapid movement	G90	Absolute dimension
G01	Feed	G91	Incremental dimension
G02	Circular interpolation (clockwise)	M03	Spindle on (clockwise rotation)
G03	Circular interpolation (anti-clockwise)	M05	Spindle stop
G17	Layer selection x-y axis	M08	Coolant on
G18	Layer selection z-x axis	X	Axis
G19	Layer selection y-z axis	Y	Axis
G40	Cancel tool correction	Z	Axis
G41	Tool path correction (left of contour)	I	Thread pitch parallel to X-axis
G42	Tool path correction (right of contour)	J	Thread pitch parallel to Y-axis
G43	Tool length compensation (call-up)	S	Spindle speed
G49	Tool length compensation (deselect)	F	Feed
G54	Zero offset		

CNC internal thread milling

1. Moving to start position
2. Moving to thread depth in bore
3. 180° descending loop to contour
4. 360° full circular movement of thread milling cutter
5. 180° exit loop to centre of bore
6. Rapid movement from bore to start position

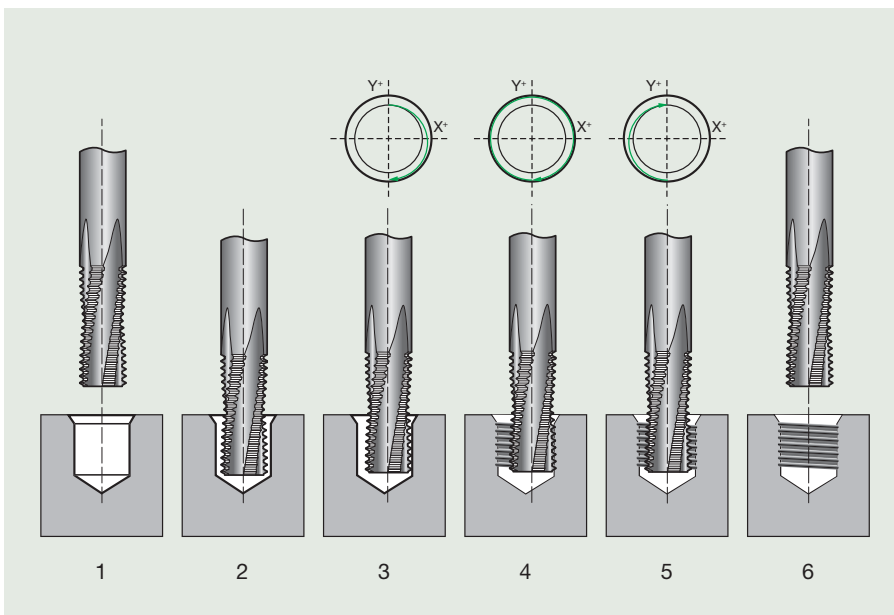
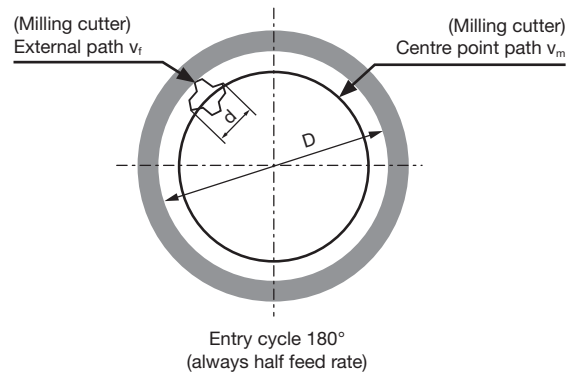

Formula of calculation

$$v_c = \frac{d \cdot \pi \cdot n}{1000}$$

$$n = \frac{v_c \cdot 1000}{d \cdot \pi}$$

$$v_f = n \cdot z \cdot f_z$$

$$v_m = \frac{v_f \cdot (D - d)}{D}$$

$$v_b = n \cdot f_b$$

- v_c = Cutting speed
- v_f = Contour feed
- v_m = Centre point path feed
- n = Revolutions
- z = Number of teeth
- f_z = Feed per tooth
- f_b = Feed per drill per revolution*
- v_b = Drill feed rate*
- D = \varnothing nom. of thread [mm]
- d = Milling cutter nom. \varnothing [mm]
- * for drill/thread milling



Thread milling programming

Programming process for micro thread milling (right-hand thread in reverse rotation)

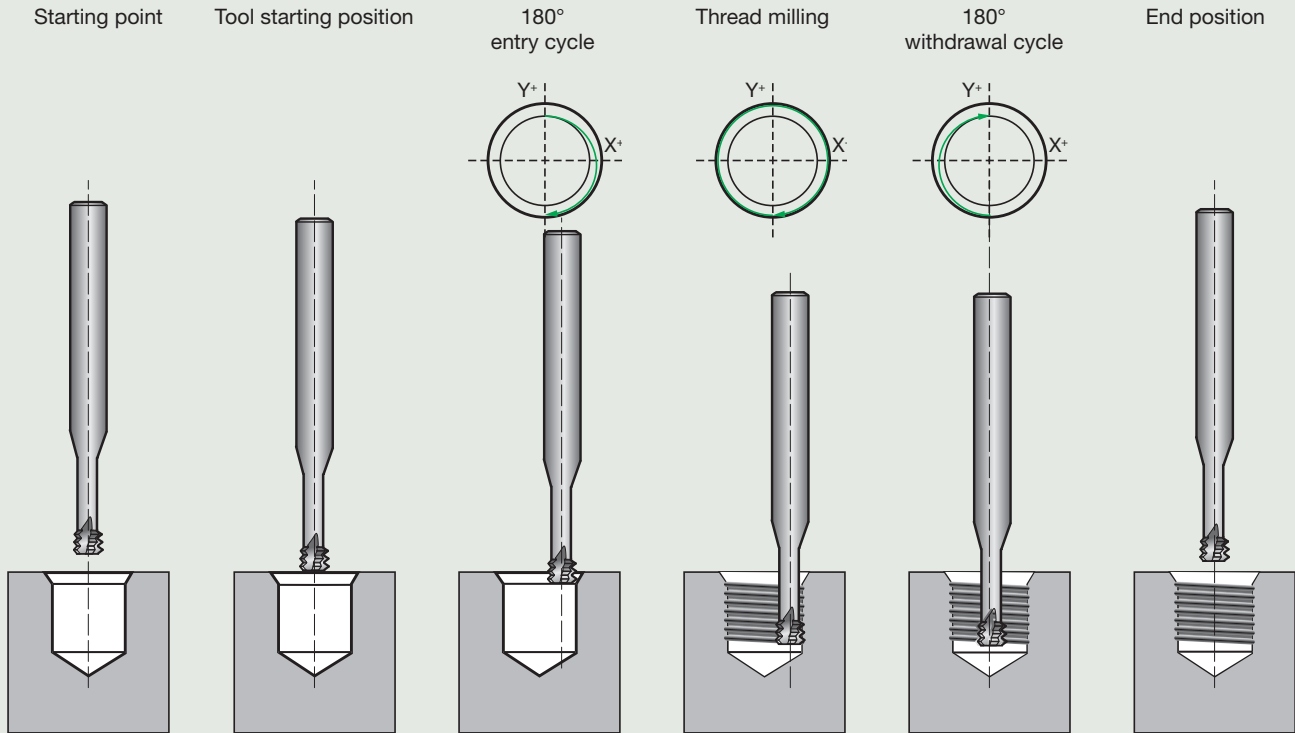

Possibilities to reduce radial forces

To reduce radial forces cut distribution can be undertaken:

Advantage

- for larger thread depths
- counteracts taper threads
- for unstable clamping conditions

Disadvantage

- increased tool wear
- longer production time

Axial distribution of cut

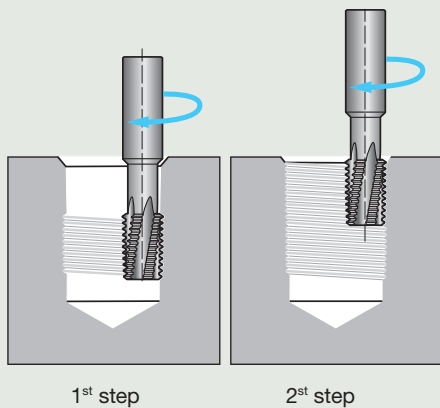

Radial distribution of cut

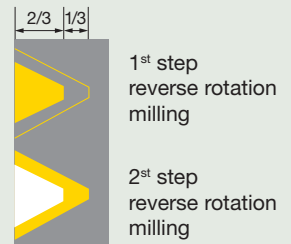
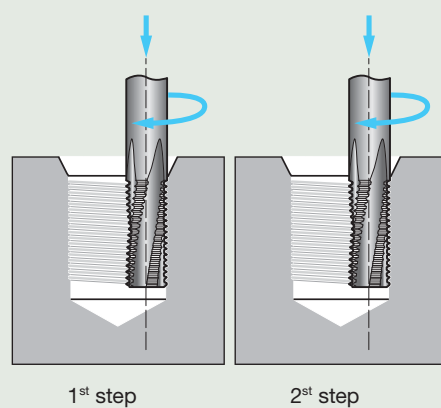



Application examples



Component	Crankcase AISi7
Machining	Boring with 180° hole base, chamfering and thread milling a pre-cast hole, through hole M20x1.5, thread depth = 20 mm
Tool	Solid carbide drill thread milling cutters DTMZ M20x1.5 with IC, 180° drill cutting edge
Cutting rates	$v_c = 250$ m/min, $f_b = 0.30$, $f_z = 0.10$ mm
Tool life	60.000 threads



Component:	Pump housing AISi12
Machining	Drilling, chamfering, facing and thread milling, blind hole M10x1, thread depth = 15 mm
Tool	Solid carbide drill thread milling cutters DTMZ M10x1 with IC and spot facer
Cutting rates	$v_c = 280$ m/min, $f_b = 0.07$, $f_z = 0.05$ mm
Tool life	24.000 threads





Selecting the correct clamping chuck

Correct tool clamping also plays an essential role with thread milling. Thread milling cutters should as a rule be clamped as short as possible. A compact and mechanical clamping force is preferable. The error in concentricity should not exceed 0.02 millimetres.

Power chucks

A power chuck excels thanks to extremely accurate concentricity. The high clamping forces and optimal smooth running are a perfect prerequisite for the production of threads in all materials including a high pitch.

max. permissible error in concentricity: 0.003 mm



Side lock holders

A side lock holder for HB and HE shanks is a robust, cost-efficient clamping chuck with a maximum clamping force. The clamping surface prevents the tool twisting or being pulled out during machining. Therefore, side lock holders are suitable for the production in all materials including a high pitch.

max. permissible error in concentricity: 0.002 mm



Shrink fit chucks

A shrink fit chuck creates a rigid connection with the shrink fitted tool. Incorrect shrink fitting or older shrink fit chucks can result in the pulling out of the tool. Tool breakage and possible loss of the component would be the consequence. Therefore, the shrink fit chuck is only suitable for a thread pitch $< P = 1.5$ mm.

max. permissible error in concentricity: 0.005 mm



Hydraulic chucks

A hydraulic chuck, similar to the shrink fit chuck, has only limited suitability for thread milling. Especially with high radial forces this clamping chuck reaches its limits. Therefore, the hydraulic chuck is recommended for softer materials such as aluminium and a thread pitch $< P = 1.5$ mm.

max. permissible error in concentricity: 0.005 mm



Collet holders

Collet chucks are very well suited for micro-thread milling because only axial stresses are created. The low clamping forces only permit the milling of softer materials. Consequently, collet holders are not suitable for conventional thread milling.

max. permissible error in concentricity: 0.01 mm





Maximum economic efficiency thanks to reconditioning to original quality

Even the most wear-resistant tool will wear sometime under heavy stresses. Thanks to the reconditioning to original geometries and coatings Hartner manages to reproduce the original performance of the tool.

Re-grinding

In our service centres, tools are re-ground on the front rake face according to the degree of wear. According to width of wear marks the re-grind service is possible two or three times (from milling part diameter $d_1 > 5.0$ mm).

In order to re-define the milling portion diameter d_1 , the number of regrinds is indicated by a notch on the end of the shank. This means every notch is assigned to a diameter and re-marked.



Re-coating

If a thread mill was enhanced with a coating, the tool is re-coated following the re-grind. This way, not only the wear and corrosion-protection as well as the glide characteristics are re-produced but also the tool life prolonged.



Application recommendations thread milling cutters and micro thread milling cutters

ISO	Material group	Hardness	Example materials	Material no.	Cutting speed v_c (m/min)	
P	Structural/free-cutting steels, unalloyed heat-treatable-/ case hardened steels	< 800 N/mm ²	S235JR	1.0037	90	
			C15	1.0401		
			11SMnPb30	1.0718		
P2	Free-cutting steels, unalloyed case hardened steels, nitriding steels	800-1000 N/mm ²	S355J2	1.0577	80	
			C60	1.0601		
P3	Alloyed heat-treatable steels, heat-treatable steels, high speed steels	800-1200 N/mm ²	31CrMo12	1.8515	70	
			42CrMo4	1.7225		
			36CrNiMo4	1.6511		
M	Stainless steel sulfured, austenitic	< 1000 N/mm ²	X36CrMo17	1.2316	55	
			HS 6-5-2	1.3343		
			X5CrNi18-10	1.4301		
	M2	Stainless and acid-resit. steel steels, martensitic	< 1000 N/mm ²	X6CrNiTi18-10	1.4571	50
				X8CrNiS18-9	1.4305	
	M3	Duplex and super duplex	< 1300 N/mm ²	X17CrNi16-2	1.4057	45
X90CrMoV18				1.4112		
X2CrTi12				1.4512		
K	Cast iron	300 HB	X2CrNiMoN22-5-3	1.4462	45	
			X2CrNiMoN25-7-4	1.441		
			X2CrNiMoCuWn25-7-4	1.4501		
	K2	Spher. graph. iron and mall. cast iron	350 HB	EN-GJL-150	0.6015	120
				EN-GJL-250	0.6025	
				EN-GJL-300	0.603	
K3	ADI, GGK	1000 N/mm ² 350 HB	EN-GJS-400-15	0.704	100	
			EN-GJS-600-3	0.706		
			EN-GJS-700-2	0.707		
N	Aluminium and wrought alloys	< 450 N/mm ²	EN-GJS1000-5	EN-GJV250	80	
			EN-GJV400			
			Al99,5H	3.025		
	N2	Aluminium cast alloys	< 600 N/mm ²	AlMgSi1	3.2315	250
				AlZn4,5Mg	3.4335	
				GD-AlSi5Cu1Mg	3.2134	
N3	Magnesium alloys	< 500 N/mm ²	GD-AlSi8Cu3	3.2162	230	
			G-AlSi9Mg	3.2373		
			G-AlSi12	3.2581		
N4	Copper and copper alloys	langspanend	GDMgAl8Zn1	3.5812.08	180	
			CuZn20	2.025		
			CuZn37Pb0,5	2.0332		
N5	Copper special alloys	< 1400 N/mm ²	kurzspanend	2.038	130	
			CuZn43Pb2	2.041		
			Ampco			
N6	Plastics [Thermoplastics, duroplastics]	langspanend	PMMA, POM,PVC		300	
			kurzspanend			
S	Titanium und titanium alloys	< 1200 N/mm ²	Titanium	3.7025	40	
			TiAl5Sn2	3.7115		
			TiAl6V4	3.7165		
S2	Nickel, cobalt, iron alloys	< 1400 N/mm ²	Hasteloy C4	2.461	30	
			Inconel 718	2.4668		
			Nimonic	2.4634		
H	High tensile steels, hardened steels	45-55 HRC	Hardox		45	
		55-62 HRC	PM30		40	

Type



Milling part diameter [d1] / feed per tooth [fz] [Conventional milling]																				
Ø1	Ø2	Ø3	Ø4	Ø5	Ø6	Ø7	Ø8	Ø9	Ø10	Ø12	Ø14	Ø16	Ø18	Ø20						
mm	mm	mm	mm	mm	mm	mm	mm	mm	mm	mm	mm	mm	mm	mm						
0.01	0.02	0.02	0.025	0.03	0.035	0.045	0.05	0.055	0.06	0.06	0.065	0.065	0.07	0.08	●●	●●	●●	●●	●●	○
0.01	0.02	0.02	0.025	0.03	0.035	0.045	0.05	0.055	0.06	0.06	0.065	0.065	0.07	0.08	●●	●●	●●	●●	●●	○
0.01	0.02	0.02	0.025	0.03	0.035	0.045	0.05	0.055	0.06	0.06	0.065	0.065	0.07	0.08	●	●●	●●	●●	●●	●
0.01	0.02	0.025	0.03	0.03	0.03	0.035	0.04	0.05	0.055	0.06	0.065	0.065	0.07	0.075	●	●●	●●	●●	●●	○
0.01	0.02	0.025	0.03	0.03	0.03	0.035	0.04	0.05	0.055	0.06	0.065	0.065	0.07	0.075	●	●●	●●	●●	●●	○
0.01	0.02	0.025	0.03	0.03	0.03	0.035	0.04	0.05	0.055	0.06	0.065	0.065	0.07	0.075	●	●●	●●	●●	●●	○
0.01	0.02	0.025	0.03	0.035	0.04	0.045	0.05	0.06	0.065	0.07	0.08	0.09	0.1	0.12	●●	●●	●●	●●	●●	○
0.01	0.02	0.025	0.03	0.035	0.04	0.045	0.05	0.06	0.065	0.07	0.08	0.09	0.1	0.12	●●	●●	●●	●●	●●	○
0.01	0.02	0.025	0.03	0.035	0.04	0.045	0.05	0.06	0.065	0.07	0.08	0.09	0.1	0.12	●●	●●	●●	●●	●●	●
0.02	0.03	0.035	0.04	0.045	0.05	0.055	0.06	0.065	0.07	0.08	0.085	0.09	0.1	0.12	●●	●●	●●	●●	●●	○
0.02	0.03	0.035	0.04	0.045	0.05	0.055	0.06	0.065	0.07	0.08	0.085	0.09	0.1	0.12	●●	●●	●●	●●	●●	○
0.02	0.03	0.035	0.04	0.045	0.05	0.055	0.06	0.065	0.07	0.08	0.085	0.09	0.1	0.12	●●	●●	●●	●●	●●	○
0.01	0.02	0.025	0.03	0.035	0.04	0.045	0.05	0.055	0.06	0.065	0.07	0.075	0.08	0.09	●●	●●	●●	●●	●●	○
0.01	0.02	0.025	0.03	0.035	0.04	0.045	0.05	0.055	0.06	0.06	0.065	0.07	0.075	0.08	●●	●●	●●	●●	●●	○
0.02	0.03	0.04	0.045	0.05	0.055	0.06	0.07	0.08	0.09	0.09	0.1	0.12	0.13	0.15	●●	●●	●●	●●	●●	○
0.01	0.01	0.015	0.02	0.025	0.03	0.035	0.04	0.04	0.045	0.05	0.055	0.06	0.065	0.07	●●	●●	●●	●●	●●	○
0.01	0.01	0.015	0.02	0.025	0.03	0.035	0.04	0.04	0.045	0.05	0.055	0.06	0.065	0.07	●●	●●	●●	●●	●●	●●
x	0.01	0.015	0.02	0.025	0.03	0.03	0.035	0.04	0.045	0.05	0.055	0.06	0.065	0.07	●	●●	●	●●	●	●●
x	0.01	0.015	0.02	0.025	0.03	0.03	0.035	0.04	0.045	0.05	0.055	0.06	0.065	0.07	○	○	○	○	○	●●

- optimally suited
- suited
- not suitable

Our programme:

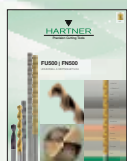

FU 500/FN 500



Gun Drills



INOX Drills



Multiplex

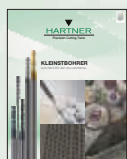

Micro Precision Drills



Multiplex HPC



TS-Drills



TM Vending Machines

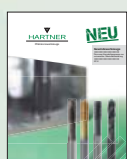

Threading Tools



Solid Carbide
High Performance Milling Cutters

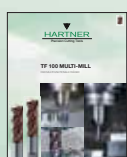

TF 100 Multi-Mill

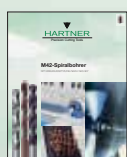

M42 Twist Drills

Hartner GmbH

P.O. Box 10 04 27, D-72425 Albstadt

Tel. +49 74 31/1 25-0, Fax +49 74 31/1 25-21 547

www.hartner.de